



Introduction

This past year has been extremely positive for the future of ISOLDE. In my introduction to last year's newsletter I stressed the strong ISOLDE contribution to the then upcoming workshop on "New Opportunities in the Physics Landscape at CERN". The very successful ISOLDE session turned out to be a huge step towards making HIE-ISOLDE a reality. It was recognized that we had a rich and varied scientific case, a large user base and a "shovel-ready" project. Events then proceeded at high speed: Yacine Kadi presented the project at the September Research Board meeting and HIE-ISOLDE was officially made a CERN project at the December meeting. The project started on January 1 with Yacine as project leader and Matteo Pasini as technical coordinator. The first Steering Committee meeting took place on January 12th and on March 19th the first General Meeting was held with more than 80 participants! The latest good news is the excellent evaluation report of the Marie-Curie training network application CATHI (Cryogenics, Accelerators and Targets at HIE-ISOLDE) which has a high probability of being funded and which will cover most of the technical fellows needed for the project. All these advances were only possible because of the detailed preparatory work for which we are indebted to the leadership of Mats Lindroos. We wish Mats all the best with his new endeavor at ESS. The next milestone will be the INTC meeting on June 23 and 24 where letters of intent for experiments at HIE-ISOLDE will be presented and discussed. So don't miss the May 21 deadline to submit yours!

A successful project should be based on a vibrant facility and that is what ISOLDE has proven to be over the last year. I will not

dwell on the highlights that you will read about in the following pages but it is important to cite, among many successful runs, the study of single particle states in ^{67}Ni through the $^{66}\text{Ni}(d,p)$ reaction; the Coulomb excitation of Fe isotopes following in-trap decay of Mn ions, the beautiful Coulex spectra obtained for ^{200}Po and the impressive Laser spectroscopy of Ga isotopes made possible by ISCOOL. Concerning fundamental interaction studies the demonstration of uniquely precise half-life measurements as well as the sustained progress made on the WITCH spectrometer point to a bright future. Different applications of the Perturbed Angular Correlation technique have led to the study of rare earth isotopes in semiconductors and of the role of metal ions in biological systems. This success is due to the dedication of the entire technical team and to the continuous improvement of the targets and ion sources (including RILIS) which make the worldwide reputation of ISOLDE. Note that during the shutdown the HRS front end was replaced as well as all the vacuum controls, and all seems ready for the startup!

A special mention should go to Alexander Herlert, whose work was instrumental in maintaining the Physics output despite several technical failures, particularly in the early part of the running period. Alex will be leaving us in September and we wish him a bright future. He will be replaced by Magdalena Kowalska, so the coordinator position will continue to be in good hands. In other news from the group, Jarno van de Walle left for KVI, EXL and the lure of higher energies. Two new fellows joined, Janne Pakarinen (Marie Curie contract) with MINIBALL and Deyan Yordanov with COLLAPS.



To disseminate our results and reach out to the community at large are among our duties. Do not forget the EURORIB'10 and HFI/NQI 2010 conferences both organized in part by ISOLDE. These are opportunities to interact with our colleagues from other European and worldwide facilities and we hope to see many of you there. The next ISOLDE workshop is scheduled for December 8-10, 2010 and you will hear more about it in the fall.

A new 4 page brochure about ISOLDE science aimed at the general public has recently been edited and is distributed to the numerous visitors who come to ISOLDE. If you would like to hand some out to your students, to your political representatives, or just to your family and friends, ask Jenny to send you a batch or pick some up when you come to ISOLDE.

Since the termination of the EURONS contract many of you have been making additional financial efforts to come to CERN for your experiments. The situation should soon improve since the second ENSAR application was highly graded and will be funded by the EC. The possibilities will be slightly less than with EURONS, but should still prove helpful to many of you. The start date of the contract is now foreseen for September 1st and we will be sending out instructions on the procedure to apply for support in due time. For those of you coming for experiments please note that with the LHC startup it is even more difficult to secure hostel rooms. So check the beam schedule and try to book as close as possible to two months ahead of your arrival, which is the earliest bookings will be accepted.

Finally the visitor's room has continued to improve (beamer, screen, strong WIFI

connection, magazines...). The only problem is that it has become more and more popular for meetings, and less accessible for the visitors!

I hope to see you soon at ISOLDE for a new successful running period.

Yorick Blumenfeld

Information for Users:

Shuttle bus

Besides the Y Bus, which goes from the CERN Meyrin Site close to Gate B directly to the airport, CERN also offers a regular shuttle service from the main building 500 to the airport. The schedule of the shuttle bus can be found here: <http://gs-dep.web.cern.ch/gs-dep/groups/sem/is/RegularShuttleTimetable.htm>

User registration

Only one form will now be used for the registration of users. The User's office will decide if it will be a short or long term registration.

If Users want to appear under a certain IS experiment number in the CERN Greybook they need to put all IS numbers on the registration form, not just the primary experiment. If you want to add an experiment to an existing registration, please ask Jenny.

The spokespersons of IS experiments should inform Jenny if there are new teams to be added to their experiment, preferably well in advance of anyone from that institute coming to CERN, so that the administrative process can be completed



and problems avoided when Users try to register.

Dosimetry service

The dosimetry service has moved to the second floor of building 55. The service is open daily 8:30 to 12:00. Please note that the service is closed in the afternoons.

Jenny Weterings

Target and Ion Source Development:

With this article I am restarting the tradition of regular reports on target and ion source development in the *ISOLDE Newletters*. I will more particularly focus for this first contribution on studies performed last year on the ISOLDE neutron converter. I find this case to be an excellent example of report since this study was done during a TISD run by an extended European collaboration comprised of members of EURISOL-DS and EUROnu projects, of GANIL and Weizmann Institutes, and of the exchange program with Slovakia¹. Second, this is a wink at the first ISOL beam produced at the Niels Bohr Institute, so-to-say "father" of the present beams, which was obtained at that time by neutron conversion with a beryllium converter and induced fissions in a uranium oxide target at close proximity [1]. Third, these tests are very valuable for both ISOLDE and the neutrino physics community in need of β -beams, a next

¹ Collaboration for this TISD program: EURISOL-DS: E. Noah, EUROnu: E. Wildner, E. Bouquerel, V. Vlachoudis, GANIL: P. Delahaye, H. Franberg, G. Lhersonneau, M. G. St Laurent, F. de Oliveira, Weizmann Institute: M. Hass, T.Y. Hirsh, V. Kumar, K. Singh, V. Vaintraub, Soreq NRC: D. Berkovits, exchange program with Slovakia: R. Hodak.

generation neutrino oscillation-type experiment [2]. Indeed this experiment investigated the possibility to produce ${}^6\text{He}$ as an antineutrino emitter by ${}^9\text{Be}(n,\alpha){}^6\text{He}$ reaction with a neutron converter and a newly available BeO target. This scheme is the baseline proposed to produce a few 10^{13} ions/s and was in need of experimental data to validate these figures. The value for ISOLDE is the opportunity to better define the neutron spectrum of its converter, for fission reactions in actinides or for yet unexplored (n,X) reactions with other targets.

We compared the energy spectrum of the emitted neutron deduced from experimental data and from Monte Carlo simulations. Experimentally this was done by activation of metal foils located in a few key positions along the converter and the target, and deconvolution with a set of selected reactions to deduce the spectrum from about 0.1 MeV to 0.1 GeV. Simulations were done with Fluka and Geant 4. The deflection and focusing of the PSBooster beam was carefully monitored thanks to dedicated SEMGrid calibrations done in the BTY transfer line ahead of the converter with the help of E. Piselli and the BE-OP-PSB section. The isotope inventory in the foils was determined by gamma spectroscopy. We obtained a good agreement of better than 30% between the simulations and the experiment in the energy range around 3 MeV, relevant for ${}^6\text{He}$ production. Isotope production and release were then monitored for different conditions with the BeO396 unit, and confirmed that more than 80% ${}^6\text{He}$ was released at 1400°C. Additional data were collected, such as the variation of the release characteristics with the temperature as we show on Fig. 1. While it was not the main goal of these tests, we delivered slightly better yields of

${}^6\text{He}$ ($>5 \times 10^7/\mu\text{C}$ in the focal plane of the separator) than the traditional production by fragmentation of UC_x targets, with a not optimally tuned production unit.

The good agreement of the numerical simulations and the experimentally obtained in-target production rates on the one hand, and the identification of a suitable BeO target with appropriate release properties and stability on the other hand, can be seen as a milestone which supports the baseline ${}^6\text{He}$ production scenario for the β -beams [3]. These tests open also the door to a new family of reactions at ISOLDE, as the one which will be tested in a coming run to produce ${}^{27}\text{Mg}$ beams by ${}^{30}\text{Si}(n,\alpha){}^{27}\text{Mg}$ reactions.

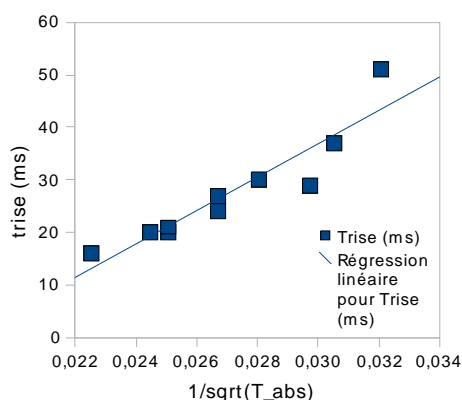
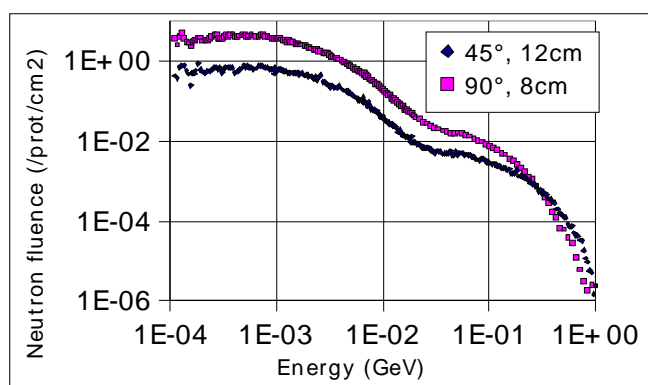

Fig 1: Left: Neutron fluence determined by Fluka simulations at 8 cm, 90° in the center of the converter and at 12 cm, 45° in the forward direction. Right: release characteristics of ${}^6\text{He}$ out of the BeO target: evolution of the rise time of the release function with respect to the target temperature.

As a conclusion, ISOLDE was already involved through many discussions in the conceptual paper on β -beams by Zucchelli [2]. The production issues for the neutrino baseline emitter, ${}^{18}\text{Ne}$, are even more challenging than for ${}^6\text{He}$. In this case again we might find good synergies between the nuclear and the neutrino physics community, since appropriate production rates could be achieved with a high power circulating molten target loop. The online tests of this prototype is an important milestone towards EURISOL, and would already improve the yields of the most exotic isotopes produced at HIE-ISOLDE with molten metal targets (e.g. neutron deficient Hg and Cd) by 2 orders of magnitude.

- [1] O. Kofoed-Hansen, K. O. Nielsen, Mat. Fys. Medd. Dan. Vid. Selsk. 26 (1951) 1.
- [2] P. Zucchelli, Phys. Letters B 532 (2002) 166.
- [3] Manuscript in preparation.

Thierry Stora

Experiment reports:

IS367: Continuum Spectroscopy of ^{10}Li

The study of the exotic nuclei is a frontier of modern nuclear physics. The isotopic chains with separation energies around the particle emission threshold play a key role in understanding the interplay of nuclear interactions and many-body dynamics. The chain of lithium isotopes (especially ^9Li - ^{10}Li - ^{11}Li) is among the best studied cases, but there are still open questions on the spectroscopy and the dynamical details of these nuclei. In this respect, a key experiment was done some time ago at REX-ISOLDE [1]. Of central importance is the neutron unbound nucleus ^{10}Li . Experimentally, structures in the low energy continuum have been identified but their spectroscopic content is still unclear. Conceptually, particle unbound nuclei like ^{10}Li require new approaches being able to account for the interaction of particle stable and particle unstable configurations.

The proper description of the pairing problem in nuclear systems is one of the key questions of contemporary nuclear physics from infinite nuclear and neutron matter to finite nuclei. We describe ^{10}Li in an extended mean-field approach including pairing type correlations in continuum configurations [2]. This is achieved by formulating the pairing problem for protons ($q=p$) and neutrons ($q=n$), in terms of a coupled channels approach leading to the Gorkov equations,

$$\begin{pmatrix} T_q + U_q - 2\lambda_q + e_\alpha & \Delta_q(\vec{r}) \\ -\Delta_q^\dagger(\vec{r}) & -(T_q + U_q - e_\alpha) \end{pmatrix} \begin{pmatrix} u_{\alpha q}(\vec{r}) \\ v_{\alpha q}(\vec{r}) \end{pmatrix} = 0$$

The quasiparticle state vectors are given by (non-relativistic) four-component spinors with the particle-type components u and the hole components v which are coupled by the pairing field Δ . With respect to the chemical potential λ , we have $e_\alpha < \lambda$ implying $2\lambda - e_\alpha > \lambda$. The Gorkov equations are solved by direct integration, imposing physical boundary conditions. We take into account differences in the radial shapes of the particle and hole wave functions, avoiding the conventional BCS approximation.

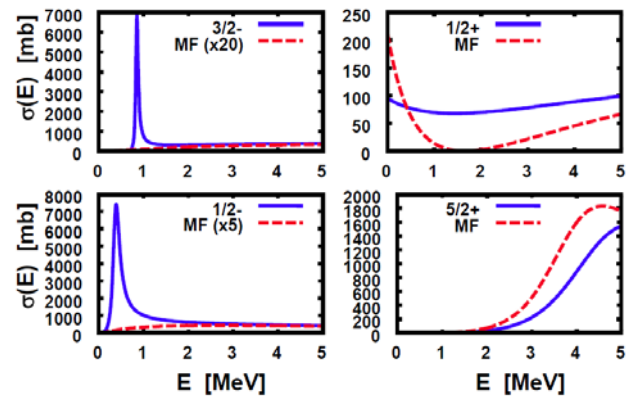

Fig. 1: Partial wave cross sections for elastic scattering of a neutron on ^9Li [2]. Results of the full HFB Gorkov-pairing and bare mean-field calculations are compared for partial waves up to d -waves. In the p -wave channels pairing contributes an attractive self-energy, producing resonances. A slight attraction is seen for the s -wave, repulsion is found for the d -wave.

The additional interactions gained from pairing produce resonances in the p -wave channels, in particular a $1/2^-$ resonance at $E_R=400$ keV and a $3/2^-$ resonance at $E_R=850$ keV, as shown in Fig. 1. The structure results are used as input for transfer reaction calculations, which are well established probes for studying the single particle properties of stable and unstable nuclei [1,3,4]. We consider the population of continuum states in ^{10}Li by a $d(^9\text{Li}, ^{10}\text{Li})p$ reaction in inverse kinematics. In Fig. 2 the results are compared to the experimental

cross sections measured in the REX-ISOLDE experiment [1] realized at $T_{\text{lab}}=2.36$ A MeV. The overall agreement is quite satisfactory. Our calculations predict as a new feature a coupled channels pairing resonance in the $3/2^-$ continuum of the $n+{}^9\text{Li}$ system.

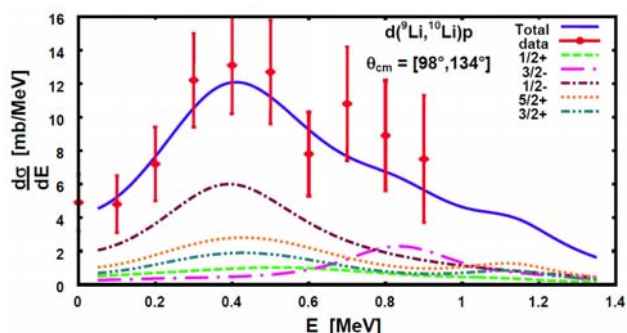

Fig. 2: Angle integrated cross section for the reaction $d({}^9\text{Li}, {}^{10}\text{Li})p$ at 2.36 A MeV [2]. The data are taken from the REX-ISOLDE experiment of ref. [1]. The theoretical results include the experimental energy resolution of $\Delta\text{FWHM}\sim 250$ keV. The $n+{}^9\text{Li}$ p -waves are seen to produce two resonance-like structures. The lower one is in the $1/2^-$ partial wave. The $3/2^-$ contribution is already suppressed because of phase space and reaction effects. The s - and d -waves partial cross sections are negligibly small.

In conclusion, for nuclei with weakly bound or unbound valence particles, pairing effects may introduce pronounced structures and shifts in the low-energy continuum of all the channels, reflecting the coupling between the particle and hole components. Such structures occur in an energy region well below the core excitation spectrum which, e.g., for ${}^{10}\text{Li}$ is starting at about the energy of the first excited state of the ${}^9\text{Li}$ -core, $E_x=2.691$ MeV. The mechanism is similar to the dynamical core polarization one, where the coupling of closed and open channels leads to a new continuum excitation mode in exotic nuclei, the Fano resonances [5]. These are a particular class of states above the neutron emission threshold characterized by asymmetric line shapes.

- [1] H.B. Jeppesen *et al.*, Phys. Lett. B 642 (2006) 449.
- [2] S.E.A. Orrigo and H. Lenske, Phys. Lett. B 677 (2009) 214.
- [3] G.R. Satchler, "Direct Nuclear Reaction", Oxford University Press (1983).
- [4] G. Blanchon, A. Bonaccorso and N. Vinh Mau, Nucl. Phys. A 739 (2004) 259.
- [5] S.E.A. Orrigo, H. Lenske *et al.*, Phys. Lett. B 633 (2006) 469.

S.E.A. Orrigo and H. Lenske

IS430: Study of neutron rich Be isotopes

In October 2009 a second experiment of low energy transfer reactions using a ${}^{11}\text{Be}$ beam was performed. This continues earlier studies of light neutron rich nuclei performed with beams of ${}^8\text{Li}$ and ${}^9\text{Li}$. The purpose of the experiment was to investigate the structure of states in ${}^{11,12}\text{Be}$, in particular to scrutinize the indication for the breaking of the $N=8$ shell in ${}^{12}\text{Be}$.

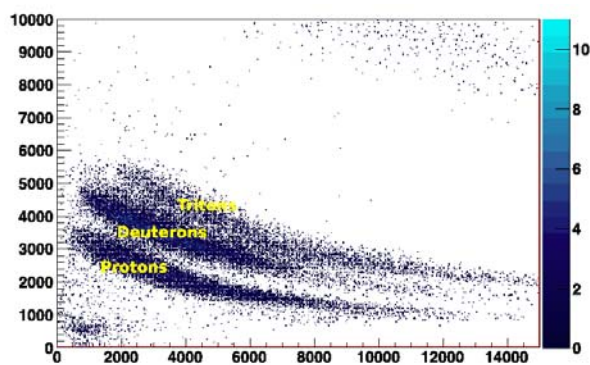

Fig. 1. dE vs E plot showing the identification of protons, deuterons and tritons.

The transfer reaction was done with a ${}^{11}\text{Be}$ beam on a deuteron target. The halo structure of the two nuclei makes a one neutron transfer likely to happen, making it possible to study ${}^{10,11,12}\text{Be}$. The single particle transfer is ideal to study one nucleon excitation as well as cluster

structures. The low energy limits the population to bound or slightly unbound states. Cluster structure has been invoked in explanation of the structure of all heavy Be nuclei, both in low lying states and at higher excitation energies where the most direct evidence has appeared so far.

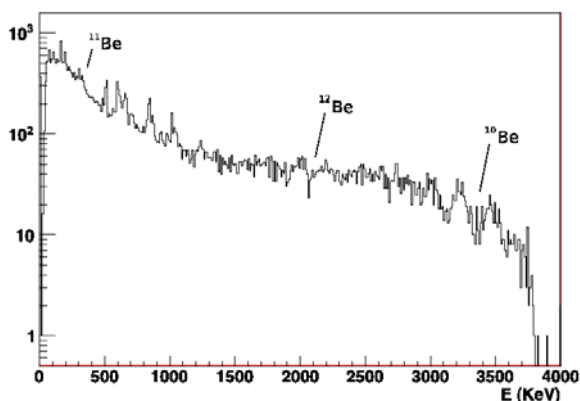

Fig 2. Energy spectrum of detected gammas. The lines corresponding to the first excited states in the three nuclei are shown. The spectrum is not corrected for doppler shift.

REX-ISOLDE was used to accelerate the ^{11}Be beam to an energy of 2.85 MeV/u. The target was deuterated polyethylene. A previous experiment performed at REX-ISOLDE in 2005 using two Double Sided silicon strip detectors for particle identification, identified the main reaction channels. In order to improve the energy resolution the MINIBALL detectors were used for gamma-detection. For particle detection the T-REX chamber was used. It contains eight pad detectors and four CD-detectors in a barrel configuration, giving almost 2π -coverage in forward direction.

Three types of particles: protons, deuterons and tritons were detected and identified as shown in Fig. 1. The three particles indicate the creation of $^{10,11,12}\text{Be}$. A preliminary energy spectrum for the gammas detected with the MINIBALL indicates population of the first excited states in the three nuclei as shown in Fig. 2. Further analysis is being

performed in order to identify other excited states and to calculate reaction cross sections.

During the experiment gammas from $^{11}\text{Be}(\beta\gamma)$ decays were also detected. These gammas have been used for relative calibration of the MINIBALL clusters up to 8 MeV.

Jacob Johansen

IS433: Technical update for the β -decay recoil spectrometer WITCH

The WITCH setup [1,2] at ISOLDE was designed to study recoil energy spectra of nuclei after β decay to search for exotic components in the weak interaction Hamiltonian. After recording a first crude recoil spectrum in the year 2006 on ^{124}In and a run on ^{35}Ar in 2007 which unveiled some technical hurdles, steps were taken to improve the experimental conditions. The main issues were the low ratio between the ions of interest ^{35}Ar and the isobaric contamination ^{35}Cl as extracted from the ISOLDE ion source (with a ratio 1 to 25), the vacuum conditions at WITCH and a huge background signal from secondary ionizations in the spectrometer.

Due to further works on the VADIS [3], especially in the choice of cleaning material for the components, the amount of stable ^{35}Cl has been reduced significantly as compared to 2007. After tuning the ion-source operation a maximum ratio $^{35}\text{Ar}/^{35}\text{Cl}$ of 5 has been obtained with a maximum count rate for ^{35}Ar of $1.1 \times 10^7/\mu\text{C}$.

Without an improvement of the vacuum conditions at WITCH a successful experiment would have been hampered by

the charge exchange of the argon ions in the cooler trap (i.e. on impurities in the helium buffer gas in this trap). For this purpose getter material has been included in the low energy part of WITCH, the buffer gas system has been completely replaced by an all-metal solution with additional gas purification, vacuum components have been thoroughly cleaned (e.g. electrodes) or replaced (e.g. teflon-coated wire) and a bake-out procedure has been optimized. The charge exchange rate is now only 10% for a trapping time of 500 ms in the cooler trap, which allows a cooling of the ions to less than 1 eV (see Fig. 1). Nonetheless, in order to make use of the entire beam as provided by ISOLDE the high charge exchange rate in REXTRAP with a half-life of about 60 ms has still to be circumvented. Possibly this can be realized by using a higher repetition rate for loading the WITCH traps. At the moment the pulsed drift tube cannot be switched faster than 1 Hz, but this will be improved in the near future.

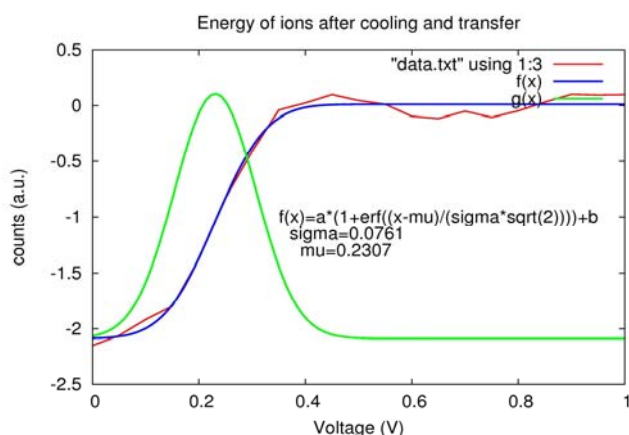

Fig. 1: An ion energy scan by the spectrometer for a typical cooling during an online run. At 0 V the full ion signal is detected, and when ramping the spectrometer the ions are reflected.

The high background at the detector could be also reduced by improving the vacuum conditions in the setup and by additionally electro-polishing the electrodes in the re-

acceleration section. Nevertheless, in the last beam time there was still a low level background, which is correlated to the radioactive decay. This noise depends on the exact voltages applied to the electrodes. This issue is currently being studied by simulations and off-line measurements. Optimal settings or a mechanical solution will be required to avoid this type of ionization which is hampering the measurement of a pure recoil ion energy spectrum with ^{35}Ar .

For the actual operation of WITCH a tremendous improvement has been achieved by fully implementing a LabVIEW-based control system starting from the CS-framework which is developed and maintained at GSI. This system is also used at other experiments, e.g. ISOLTRAP. The CS-framework has been outfitted with WITCH specific extensions like the possibility to scan electrode potentials, excitation frequencies as well as timings in the experimental cycle. This allowed achieving a better transfer to and between the traps and a lower ion energy after transfer between the traps [3].

The plans for 2010 foresee to measure the response function of the entire system and to perform a new run with ^{35}Ar . The response function will be measured with ^{144}Eu . This is a β^+ decaying nucleus with a large fraction of electron capture decays. The mono-energetic recoils from the electron capture decays will provide us an opportunity to fully characterize the entire system and measure the response function of our detection system (spectrometer + MCP detector). This depends on the conditions of the radioactive ion cloud in the decay trap, and the adiabatic conversion in the spectrometer, but other effects might also play a role. Finally, after having studied



the low level ionization and having implemented adequate solutions to eliminate this we aim to measure a recoil ion energy spectrum with ^{35}Ar that should provide us with new physics information.

- [1] M. Beck *et al.*, Nucl. Instr. and Meth. A 503 (2003) 567.
- [2] V.Yu. Kozlov *et al.*, Nucl. Instr. and Meth. B 266 (2008) 4515.
- [3] L. Penescu *et al.*, Nucl. Instr. and Meth. B 266 (2008) 4415.

Michael Tandecki for the WITCH Collaboration

IS437: Precise half-life measurements for ^{38}Ca and ^{39}Ca

Nuclear β decay is a commonly used probe to study the properties of the atomic nucleus. As β decay is governed by the weak interaction, it may also be used to test the light-quark sector of the Standard Model (SM). The SM incorporates the conserved-vector-current (CVC) hypothesis, which assumes that the vector part of the weak interaction is not influenced by the strong interaction. Thus, the vector current should not be renormalized in the nuclear medium. The comparative half-life ft of a particular class of β -decaying nuclides gives access to the vector coupling constant g_v used to test CVC [1]. As a further test, the combination of g_v with the leptonic vector coupling constant allows for the determination of the up-quark down-quark element V_{ud} of the Cabibbo-Kobayashi-Maskawa quark-mixing matrix, which, according to the SM, is unitary. V_{ud} has by far the most significant weight in such a unitarity test.

The experimental quantities necessary for the determination of ft are: the β decay energy Q_{EG} , the half-life $T_{1/2}$, and the super-

allowed branching ratio BR . Theoretical corrections to this ft value must be determined by models [2]. The corrected Ft values have been determined for thirteen super-allowed Fermi decays of the $0^+ \rightarrow 0^+$ type, with a precision close to or better than 10^{-3} [1].

The use of β decay between mirror nuclei is an extension of the work based on the decay of the neutron. In this case, the same quantities, i.e. Q_{EG} , $T_{1/2}$, and BR have to be determined. However, as for these systems the Gamow-Teller β decay contributes to the decay strength towards the isobaric analogue state in the β -decay daughter nucleus, an additional parameter, a β - ν correlation coefficient, has to be measured to determine the fraction of Fermi decay [3].

In an experiment at the ISOLDE facility [4], we have used the new technique of trap-assisted preparation of the radioactive samples with REXTRAP to prepare pure samples of $^{38,39}\text{Ca}$. For ^{38}Ca , we could improve the uncertainty of the half-life by more than a factor of four. For ^{39}Ca , never before measured with a clean sample, we reached a precision of 0.1%.

The isotopes of interest were produced by spallation of a titanium-foil target. A fluorine leak in the ion source allowed for the production of CaF^+ side-band molecules, which were mass separated by the ISOLDE High-Resolution Separator (HRS) and accumulated in the REXTRAP Penning trap facility. After an accumulation time of 600 ms, an ejection pulse emptied the trap and sent the sample to a tape station. This ejection allowed a time-of-flight (TOF) selection of mass $A=57$ in the case of ^{38}Ca and of $A=58$ in the case of ^{39}Ca . The tape transported the activity in the centre of a

detection setup of Geiger gas counters for the β particles. Germanium detectors allow for testing the purity of the sources. After the end of the measurement period a new source was accumulated in REXTRAP and a new cycle started.

Figure 1 shows the decay-time curve for one run which is the sum of many hundred cycles. The figure shows the different contributions to the spectrum. About 35 such runs were accumulated for ^{38}Ca ; three runs under different experimental conditions were acquired for ^{39}Ca .

The final result for the half-life of ^{38}Ca from the present work (443.8(19) ms) compares well with literature values. All values are in mutual agreement and yield an average value of 443.6(18) ms.

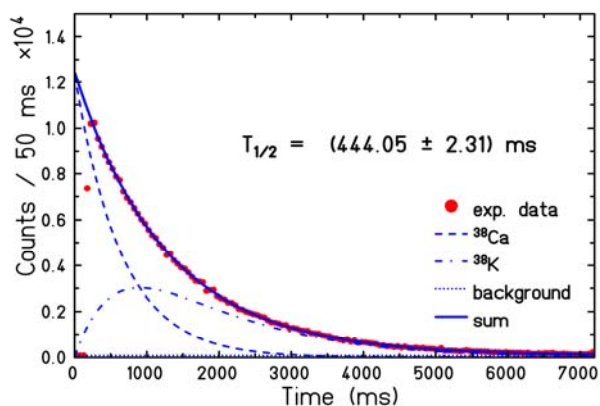

Fig. 1: Decay-time spectrum for one run to determine the half-life of ^{38}Ca . The different curves give the different contributions to the spectrum as well as their sum.

The result for ^{39}Ca (860.7(10) ms) is also in nice agreement with literature values. We reach the same precision as other groups before. The final average value of 860.6(8) ms has a precision of 10^{-3} and is thus sufficiently precise for the scientific goals laid out in the introduction.

In summary, high-precision half-life measurements have been performed for $^{38,39}\text{Ca}$ using the REXTRAP facility to prepare pure sources. Although the precision goal has not been reached for ^{38}Ca , the experiment demonstrated that such precision studies are feasible at ISOLDE. In the case of ^{38}Ca , a high-precision branching-ratio measurement is needed to include this nucleus in the systematics of high-precision Ft values. For ^{39}Ca , a β - ν angular correlation coefficient has to be determined to include this nucleus in the systematics of mirror decays.

- [1] J.C. Hardy, I.S. Towner, Phys. Rev. C 79 (2009) 055502.
- [2] I.S. Towner, J.C. Hardy, Phys. Rev. C 77 (2008) 025501.
- [3] O. Naviliat-Cuncic, N. Severijns, Phys. Rev. Lett. 102 (2009) 142302.
- [4] B. Blank *et al.*, submitted to Eur. Phys. J. A

Bertram Blank

IS447: Structures of ^{201}Po and ^{205}Rn from EC/ β^+ -decay studies

The magic numbers near the beta stability line are well-established from experimental information. It is now known that these numbers are no longer "magic" on the neutron-rich side of the nuclear chart near $N=8,20,28,50$ and even 82 [1]. This effect is attributed to a shell quenching which arises when the Woods-Saxon potential moves towards a harmonic-oscillator type. No such effects have been observed for neutron-rich nuclei near $N=126$. As part of a wider effort to obtain relevant experimental information, an experiment was performed in July 2008 to test the robustness of $N=126$ shell closure, by studying isomeric-decays in neutron-rich gold isotopes. However, due to some

experimental difficulties it was not possible to populate the gold isotopes and hence the isomeric states in them. However, some new information on single-particle structures in the $Z > 82$ and $N < 126$ region has been deduced which we report here.

The experiment was performed at the ISOLDE General Purpose Separator (GPS). The GPS was set to transport the $A=205$ products, which were collected on a magnetic tape and transported to a measurement station at regular time intervals of 16.8 s. At the measurement station the source could be viewed by an electron spectrometer and two HPGe detectors. The electron detection system incorporated a MINI-ORANGE spectrometer and a 4 mm thick Si(Li) detector with an active area of 300 mm². For the MINI-ORANGE spectrometer a set of 6 equally spaced permanent magnets was used. The distance between the MINI-ORANGE spectrometer and the detector was chosen to be 110 mm so as to maximize electron transmission efficiency in the energy range of 400-800 keV.

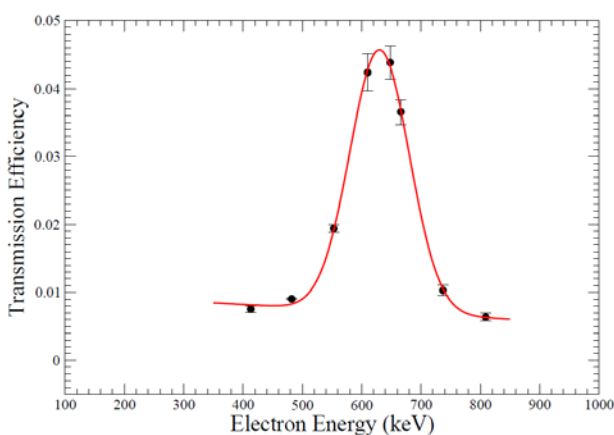

Fig. 1: Electron transmission efficiency curve for MINIORANGE.

The transmission efficiency curve of the MINI-ORANGE spectrometer as shown in Fig. 1 was obtained using transitions of well

established internal conversion coefficients from sources of $^{190,194}\text{Hg}$ and ^{203}Pb delivered at different mass settings of the GPS and transitions from a ^{207}Bi source. The two HPGe detectors were located at 90° and 180° with respect to the Si(Li) detector and the beam direction. They had absolute efficiency of $\sim 0.3\%$ and energy resolution of ~ 2.0 keV at 1.3 MeV. The data were collected using a commercially available trigger-less digital data acquisition system Pixie4. In total, five parameters (one signal from the magnetic tape movement, two from the HPGe pre-amplifiers, one from the Si(Li) pre-amplifier and one from the proton pulse) were recorded and time-stamped.

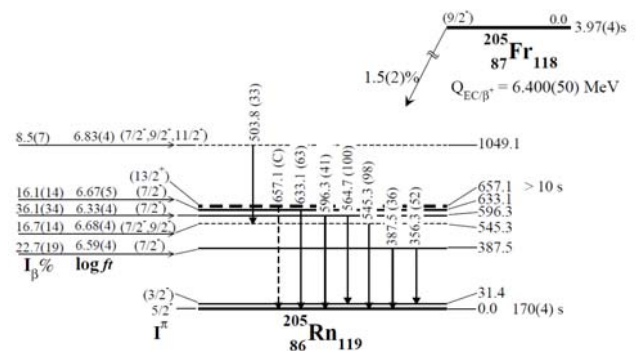

Fig. 2: Level scheme of ^{205}Rn as obtained from the present work. All the transitions are labeled with their energies and relative γ -ray intensities in brackets. Also, all the levels are labeled with their corresponding excitation energies (on the right). "C" indicates that the γ -ray transition is highly contaminated (and for the 657.1 keV transition the placement is based on K-shell conversion electrons).

^{205}Fr decays predominantly by α emission. An upper limit of only 1% for the EC/ β^+ -decay to ^{205}Rn was established earlier [2]. The ground state was assigned $I^\pi=5/2^-$ for ^{205}Rn using hyperfine interactions and isotope shift techniques [3]. Many positive-parity high-spin states in ^{205}Rn were known prior to this work [4]. Apart from this, only two states at 387.0(5) and 633.7(11) keV were identified in the alpha-decay of ^{209}Ra [5].



In our work, we determine the EC/β^+ branching to be 1.5(2)% from the intensities of the γ -ray transitions in ^{201}Po and ^{205}Rn , and assuming a 29% EC/β^+ decay branch from ^{201}At . Further details on experimental results are discussed in Ref. [6].

No excited negative-parity states were known in ^{205}Rn , but these are expected to occur as the result of the coupling of the odd neutron with the positive-parity core states. The shell-model orbitals accessible to the odd neutron at low energies are $f_{5/2}$, $p_{3/2}$ and $p_{1/2}$ for negative parity and $i_{13/2}$ for positive parity. The levels at 0, 31.4 and 657.1 keV could be understood as one-quasiparticle states originating from coupling the odd $f_{5/2}$, $p_{3/2}$ and $i_{13/2}$ neutron to the 0^+ ground state of the core, respectively. However, it was not possible to establish the $1/2^-$ state. This is also not unexpected as only the states with spin values near to the parent ground state spin of $I^\pi=9/2^-$ would be strongly populated in the β -decay, due to selection rules. All the transitions to levels in ^{205}Rn have $\log ft$ limits very close to 7 (see Fig. 2) indicating that the levels are populated in the allowed and first forbidden beta decays.

The states around 600 keV could be understood as states originating from the coupling of the odd neutron in $f_{5/2}$, $p_{3/2}$, and $p_{1/2}$ orbitals to the 2^+ even-even core state (e.g. at 575.3 keV in ^{206}Rn). Such a coupling actually results in one $9/2^-$ state, two $7/2^-$ states, three each of $5/2^-$, $3/2^-$, and two $1/2^-$ levels. However, not all of them could be observed in the present work as they are not very strongly populated in the β -decay of the $9/2^-$ ground state of ^{205}Fr . Similar considerations suggest that a large number of states should also be found near 1100 keV (from coupling to the 4^+ core

state), 1700 keV (from coupling to the 6^+ and 8^+ core states) and so on. The two groups around 600 and 1050 keV fit the expected pattern quite well, as is evident from Fig. 2.

We have found evidence [6] for a long-lived ($13/2^+$) isomer, but a longer tape-transport period would seem to be needed in order to confirm the assignment.

The authors would like to acknowledge the ISOLDE technical staff for their assistance during the experiment. Financial support from the UK STFC and AWE plc., the Spanish MEC FPA2007-07393, CSPD-2007-00042 CPAN, FPA2005-03993, and FPA 2008-06419-C02-01 projects is gratefully acknowledged.

- [1] I. Dillmann *et al.*, Phys. Rev. Lett. 91 (2003) 162503.
- [2] F.G. Kondev, Nucl. Data Sheets 101 (2004) 521.
- [3] W. Borchers, *et al.*, Hyperfine Interact. 34 (1987) 25.
- [4] J.R. Novak *et al.*, Phys. Rev. C 59 (1999) R2989.
- [5] F.P. Heßberger *et al.*, Eur. Phys. J. A 16 (2003) 365.
- [6] A.Y. Deo *et al.*, Phys. Rev. C 81 (2010) 024322.

Ajay Y. Deo

IS456: The polonium saga continues

The development of an efficient laser ionisation scheme for the polonium isotopes with the RILIS [1] has led to many new experimental programs capitalising upon the new pure beams. The first of those was a study of the polonium isotopic chain mean-square charge radii (MSCR) by means of in-source laser spectroscopy. The high sensitivity of this technique, as demonstrated in the study of the lead isotopes [2,3], allows the study of very exotic isotopes at the edge of what ISOLDE can provide.

In the first experimental campaign performed in 2007 [4], 10 polonium isotopes (plus 4 isomers) had been studied. The analysis revealed that a larger overlap with the previously available data was required to extract the MSCR. An extended campaign in 2009, 11 more isotopes ($^{191-192,201,203,206-211,216,218}\text{Po}$) and 3 more isomers ($^{191m,201m,203m}\text{Po}$) were investigated.

The neutron-deficient isotopes $^{191-192,201,203}\text{Po}$ were directly produced via the spallation of a UC_x target. The presence of surface-ionised francium, however, hindered the measurement of the other isotopes. Those were studied instead via delayed production by first irradiating the target (while measuring the neutron-deficient isotopes) and then stopping the proton beam request. The accumulated amount of beta-decaying $^{206-211}\text{At}$, and alpha-decaying ^{224}Ra and ^{222}Rn provided a steady supply of the isotopes $^{206-211,216,218}\text{Po}$, respectively, for several hours (up to 10!!) after last irradiating the target.

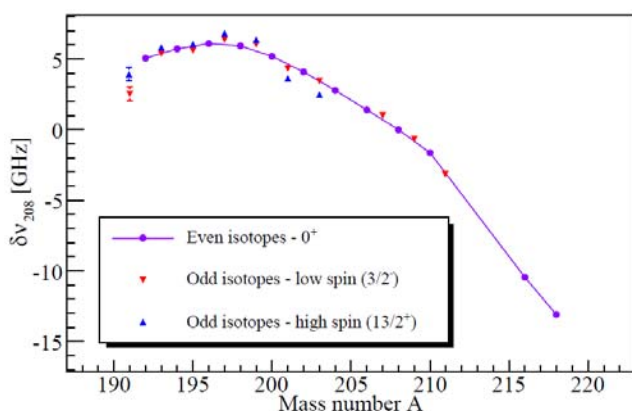

Fig. 1: Isotope shift in the polonium isotopic chain from ^{191}Po to ^{218}Po measured using the $6p^37s^5S_2$ to $6p^37p^5P_2$ transition at 843.38 nm by in-source laser spectroscopy. The error bars for all isotopes but ^{191}Po are smaller than the data points.

The RILIS dye lasers were pumped using the new Nd:YAG laser, which provided more power for the ionisation scheme and

improved stability for in-source laser spectroscopy. This increase in laser ionisation efficiency, together with a fresh target and good running conditions resulted in the possibility to study the exotic isotopes ^{191}Po , with half-lives 22 ms and 93 ms for the low-spin and high-spin isomers, respectively, and ^{192}Po , with half-life 33 ms. Those were observed with as few as 0.01 ions per second for ^{191}Po and 0.3 ions per second for ^{192}Po at the peak of the resonance.

The short-lived isotopes $^{191-192,211,216}\text{Po}$ ($T_{1/2} < 1\text{s}$) and ^{218}Po ($T_{1/2} = 3\text{min}$) were identified via their characteristic alpha decay at the Windmill Si detector measuring station, located at LA1 to minimise the background from free-drifting radon isotopes. Those had been observed in the first campaign when the Windmill was placed at GLM, much closer to the separator. The isotopes $^{201,203}\text{Po}$ were identified via gamma rays following their beta decay at the ISOLDE tape station; finally, the longer-lived isotopes $^{206-210}\text{Po}$ were counted in Faraday cup FC490 after the General Purpose Separator (GPS).

This comprehensive data set now spans as much of the isotopic chain as is currently available at ISOLDE, from ^{191}Po up to ^{218}Po . The isotope shifts with respect to ^{208}Po are shown in Fig. 1. A clear break in the trend can be observed beginning at $A=200$ moving towards the lighter isotopes. This shall manifest in the MSCR by a large departure from the trend of spherical nuclei, as established by the lead isotopes [2,3]. The extraction of the MSCR requires, however, a careful consideration of the atomic parameters. Knowledge of the atomic parameters is hampered by the radioactive nature of the nuclei concerned rendering them unavailable for detailed

study at an off-line facility. Therefore, we must rely on large scale atomic calculations [5].

- [1] T.E. Cocolios *et al.*, Nucl. Instr. and Meth. B 266 (2008) 4403 (EMIS2007 Proceedings).
- [2] H. De Witte *et al.*, Phys. Rev. Lett. 98 (2007) 112502.
- [3] M. Selivertov *et al.*, Eur. Phys. J. A 41 (2009) 315.
- [4] T.E. Cocolios, ISOLDE Newsletter (2008) 24.
- [5] S. Fritzsche, Physica Scripta T100 (2002) 37.

Thomas Cocolios

IS457: Laser Spectroscopy of gallium isotopes using ISCOOL

In 2009 the COLLAPS Collaboration completed the study of neutron-rich gallium isotopes. Laser spectroscopy was performed, now covering isotopes from $A=67$ to $A=82$, using the ion beam cooler ISCOOL. Bunches of a temporal length within $6 \mu\text{s}$ were released from the device after every $50 \text{ ms} - 200 \text{ ms}$ of accumulation. By vetoing the photon counts which were outside of the laser – ion bunch interaction time, the photon background was suppressed by 4 orders of magnitude. Figure 1 shows the (photon gated) spectra for the odd- A Ga isotopes (measured on the $417 \text{ nm } J=3/2 \rightarrow J=1/2$ atomic line).

Although odd- A and odd-odd gallium isotopes have been measured, the analysis of the odd- A gallium isotopes has been undertaken as a priority. The measurements of the ground state nuclear spin provided by laser spectroscopy established that a spin inversion (due to monopole migration of the $\pi f_{5/2}$ level) occurs between ^{79}Ga and ^{81}Ga .

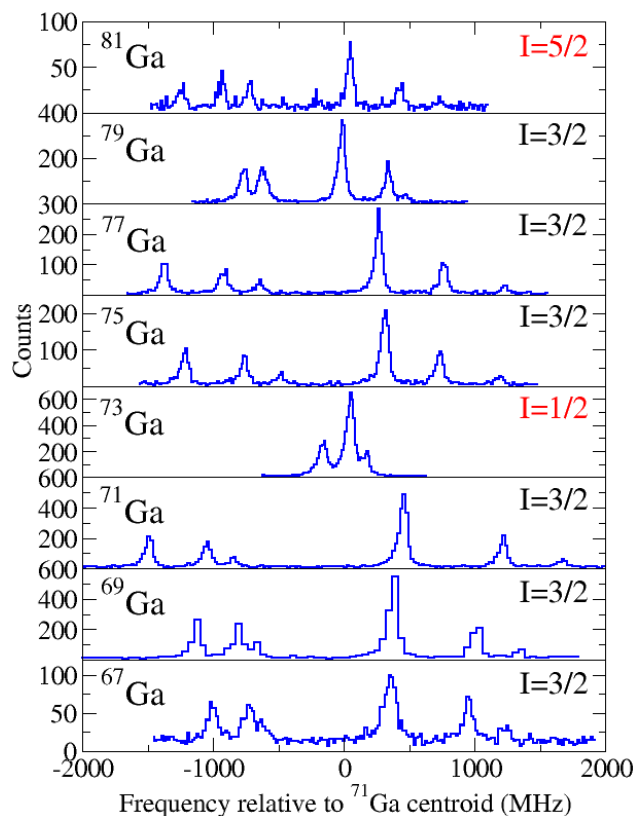

Fig. 1: Photon gated spectra for the odd- A Ga isotopes.

Energy levels, spins and moments have been investigated using the JUN45 and jj44b effective shell model interactions. The analysis of the magnetic dipole and electric quadrupole moments show an emptying of the $\pi p_{3/2}$ with increasing mass number, starting at $N=42$ already [1]. Although the magnetic moments are similar for $^{67,69,71}\text{Ga}$ and $^{75,77}\text{Ga}$, a structural change from a positive to a negative quadrupole moment takes place at the location where the ground state was unexpectedly found in this work to be a collective spin $1/2$ structure. Although the ground state of ^{79}Ga has spin $3/2$, the influence of the $\pi f_{5/2}$ is evidenced in the nuclear moments and confirmed by shell model calculations.

In 2010, the collaboration will study the neutron-deficient gallium isotopes in order

to establish (or otherwise) the existence of a proton skin around ^{62}Ga .

[1] Cheal *et al.*, Phys. Rev. Lett., in preparation

Bradley Cheal

IS467&IS468: Exotic excursion south of ^{68}Ni – on the way to a new island of inversion?

The island of inversion around $Z=10-12$ and $N=20$ is by now a well studied region of the nuclear chart, mainly thanks to the availability of intense radioactive ion beams of the isotopes of interest. A new island of inversion has recently been suggested to exist south of ^{68}Ni , namely in the neutron-rich Cr ($Z=24$) and Ti ($Z=22$) isotopes around $N=40$ [1]. These isotopes are currently not available with sufficient intensity at any radioactive ion beam facility. Though, the nuclear structure of Fe isotopes ($Z=26$) around neutron number $N=40$ can be investigated experimentally already. The experimental observations can serve as benchmarks for any theoretical model applicable in this region of the nuclear chart.

Unique structural information on neutron rich Fe isotopes ($A=60-68$) has been obtained by performing a beta decay experiment on $^{58,60-68}\text{Mn}$ at ISOLDE (IS467). These neutron-rich Mn beams have been available for many years thanks to the development of the selective and efficient resonance ionization laser ion source (RILIS). In 1999 a first beta decay experiment was performed on $^{61-69}\text{Mn}$ [2]. Half-lives for $^{61-69}\text{Mn}$ were determined from beta-delayed neutron emission and for $^{64,66}\text{Mn}$, beta-coincident gamma-ray data was taken. The latter yielded a first

indication for onset of deformation in ^{66}Fe , the first even-even nucleus south of ^{68}Ni [2].

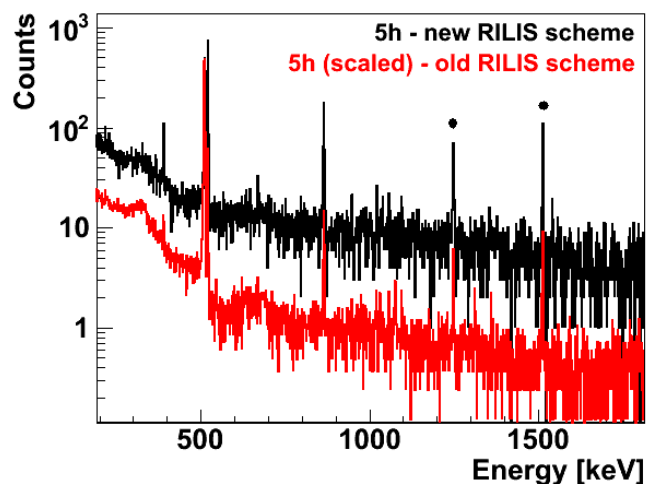

Fig. 1: Gamma spectrum observed in the beta decay of ^{68}Mn . The red/black spectrum was measured with the "old"/"new" RILIS ionization scheme. Lines indicated with a filled circle have been observed for the first time.

IS467 focused on the beta decay of $^{58,60-68}\text{Mn}$, utilizing the LISOL tape station, comprising two MINIBALL triple cluster detectors and three plastic beta counters mounted close to the implantation point. This setup was established at the LISOL separator at the CRC (Louvain-la-Neuve, Belgium).

A rich harvest of high statistics and clean gamma spectra were obtained and the analysis is still very preliminary. In Fig. 1, one of the highlights is shown, namely the spectrum observed in the beta decay of ^{68}Mn . This spectrum is complementary to the recently observed levels in ^{68}Fe from one- and two-proton knockout reactions at the NSCL in-flight facility of Michigan State University. In our data, we observe two new states (see Fig. 1) and it will be possible to constrain the spin and parities of all the observed states.

Online, the RILIS ionization efficiency could be increased for Mn isotopes with $A > 65$, resulting in a factor 10 increase of the yield. Thanks to this unanticipated development, the spectroscopy of the ^{68}Fe could be performed with relatively high statistics. In Fig. 1, a comparison is made between the observed beta-decay gamma spectrum of ^{68}Mn with the "old" and the "new" ionization scheme, both scaled to a measuring time of 5 hours for comparison.

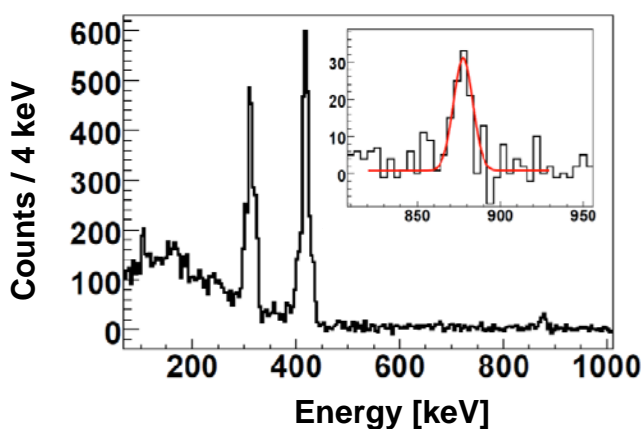

Fig. 2: Doppler corrected Coulomb excitation spectrum of the $A=62$ beam ($\text{Mn}+\text{Fe}$), measured with the MINIBALL germanium array at a beam energy of 2.86 MeV. The $2^+ \rightarrow 0^+$ transition in ^{62}Fe at 877 keV is clearly visible after Doppler correction.

With the experiment IS468, we aimed at measuring the $B(E2)$ transition probability to the first excited 2^+ state in ^{62}Fe , this to further investigate the onset of collectivity in the neutron rich Fe isotopes. The post-accelerated Fe beam was obtained via in-trap decay of ^{62}Mn ($T_{1/2}=671(5)$ ms [2]) in the REXTRAP and EBIS combination. Again, the data is still under evaluation, but a $B(E2)$ value for ^{62}Fe will become available and is complementary to the lifetime of the 2^+ state measured recently in ^{62}Fe at various in-flight facilities around the world. Until now, low energy Coulomb excitation on neutron rich Fe isotopes is only possible at REX-ISOLDE, utilizing the new method of in-trap decay of the unique laser ionized Mn

beams. In Fig. 2, the Coulomb excitation spectrum is shown for $A=62$, clearly identifying the $2^+ \rightarrow 0^+$ transition in ^{62}Fe at 877 keV (after Doppler correction) and the target de-excitation lines at 312 keV and 415 keV from ^{109}Ag .

In summary, a very successful excursion south of ^{68}Ni has been made by our collaboration (IS467 and IS468) in 2009. Much of the success can be attributed to the availability of the unique and intense Mn beams at ISOLDE. These are the first steps in the direction of the anticipated island of inversion around the extremely exotic ^{64}Cr and ^{62}Ti .

- [1] P. Adrich *et al.*, Phys. Rev. C 77 (2008) 054306.
 [2] M. Hannawald *et al.*, Phys. Rev. Lett. 82 (1999) 1391.

Jarno Van de Walle

IS469: Single-particle states in ^{67}Ni

Magic numbers are considered as cornerstones for modelling the structure of the atomic nucleus. From this point of view the region around ^{68}Ni with its closed proton shell ($Z=28$) and closed neutron harmonic-oscillator sub-shell ($N=40$), is particularly interesting as neutrons start to fill the $g_{9/2}$ unique-parity orbital. Recently, the collective features of neutron-rich Ni, Cu and Zn isotopes in the neighborhood of ^{68}Ni have been studied by means of the Coulomb excitation technique [1-3]. Despite these and other extensive studies, the specific influence of the neutron $g_{9/2}$ orbital on the nuclear structure in this mass region has not yet been fully understood. One neutron transfer reactions are a unique tool to study and further investigate the nuclear structure in this mass region, as they probe

the single particle character of the wave function. This technique has now been used at ISOLDE in order to investigate the structure of ^{67}Ni – which might be described as a neutron hole coupled to ^{68}Ni – by performing a $^{66}\text{Ni}(d,p)^{67}\text{Ni}$ experiment in inverse kinematics [4].

The experiment was performed in November 2009 by directing a post-accelerated ^{66}Ni beam with an energy of 3 MeV/u on a deuterated polyethylene target with a thickness of only $100\ \mu\text{g}/\text{cm}^2$. This is the heaviest beam used for transfer reaction experiments at ISOLDE so far. The protons from the (d,p) reaction were detected by the T-REX particle detection array [5] in coincidence with gamma rays emitted by the populated levels. The resulting gamma rays were registered by the MINIBALL gamma detection set-up. Thanks to the high beam intensity of 3×10^6 pps and the high purity of the beam – of nearly 99% – good quality data could be acquired. Some very preliminary results are shown in Fig. 1, where the excitation energy of ^{67}Ni – which is deduced from the energy deficit of the detected protons – is shown together with the coincident gamma rays. The Q -value of this reaction is 3.6 MeV. From this figure it can be seen that levels with an excitation energy of up to 5.5 MeV were populated by the reaction. A slow correlation technique, whereby gamma rays detected in the beam dump detector were correlated with the detected protons in T-REX over a period of about $60\ \mu\text{s}$, was successfully used to establish direct populating and feeding via gamma decay of the $g_{9/2}$ 13.3 μs isomer in ^{67}Ni .

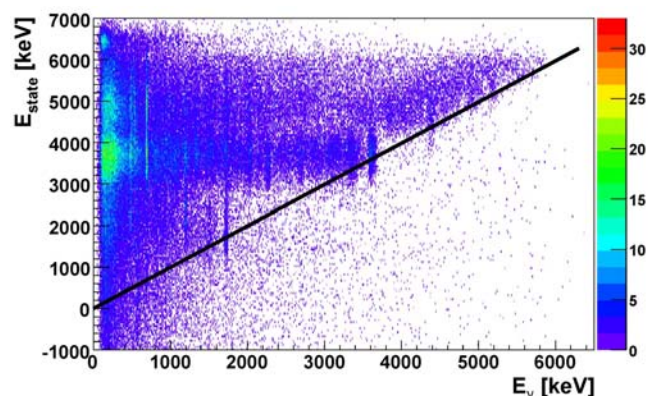

Fig. 1: An (on-line) produced spectrum of the excitation energy of ^{67}Ni versus coincident Doppler-corrected gamma-ray energy. The line shows the position of excited states in ^{67}Ni that decay directly to the ground state via a single transition.

In a more advanced phase of the analysis, the extracted angular distributions of the protons will be compared to DWBA calculations in order to determine the angular momentum transfer. In this way the spin and parity assignments of the newly observed levels will be feasible. Furthermore, the deduced relative spectroscopic factors will be compared to those from different theoretical predictions [6,7], in order to improve our understanding on the nuclear structure and the role of the $g_{9/2}$ orbital in this mass region.

- [1] I. Stefanescu *et al.*, Phys. Rev. Lett. 100 (2008) 112502.
- [2] J. Van De Walle *et al.*, Phys. Rev. Lett. 99 (2007) 142501.
- [3] N. Bree *et al.*, Phys. Rev. C 78 (2008) 047301.
- [4] N. Patronis *et al.*, CERN-INTC 2008-007 and INTC-P-238 (2008).
- [5] V. Bildstein *et al.*, Prog. Part. Nucl. Phys. 59 (2007) 386.
- [6] A.M. Oros-Peusquens and P.F. Mantica, Nucl. Phys. A 669 (2000) 81.
- [7] N.A. Smirnova *et al.*, Phys. Rev. C 69 (2004) 044306.

Jan Diriken

IS479: Shape transition in the neutron-deficient Po isotopes

The coexistence of shapes observed at low-excitation energy in the vicinity of neutron-deficient $Z=82$ nuclei close to the neutron midshell region around $N=104$ results from three main effects [1-3]: the promotion of proton pairs across the $Z=82$ gap which requires about 7 MeV, a strong gain in binding energy arising from the increased pairing energy (because of extra valence proton particle and hole pairs) and the increase in proton-neutron interaction. The latter is determined by the number of active neutrons which maximizes around $N=104$ mid shell between $N=82$ and $N=126$. In the $Z=82$ region, protons and neutrons act coherently to produce low-lying oblate and prolate shapes that might coexist with a spherical configuration [4]. The shape coexistence phenomenon is well-established in the neutron-deficient polonium isotopes [5-6] and the strong perturbation of the energy-level systematics in the very light polonium isotopes has been interpreted as arising from the mixing between the different structures [6-9].

While the onset of the collectivity in the light polonium isotopes is reasonably well established experimentally, questions remain concerning the sign of deformation and the magnitude of the mixing between different configurations. Furthermore, controversy is present with respect to the transition from the vibrational-like character of the heavier polonium isotopes to a structure driven by shape coexistence as observed in the lighter polonium isotopes. From level systematics it appears that ^{200}Po lies at the borderline between these two regimes.

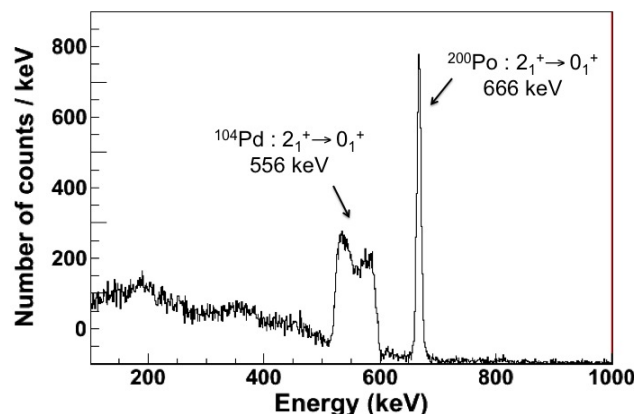

Fig. 1: Part of the gamma-ray spectrum from the Coulomb excitation of 570 MeV ^{200}Po ions on a 2.0 mg/cm^2 ^{104}Pd target, recorded in the MINIBALL gamma spectrometer in coincidence with charged particles detected in a Si annular detector. The Doppler correction has been performed for the projectile excitation and the random coincidences were subtracted.

To date, the experimental $B(E2; 2^+ \rightarrow 0^+)$ value has been extracted only for $^{194,196}\text{Po}$ from lifetime measurements, using the recoil-decay tagging technique [10-11]. This experiment has confirmed the high collectivity of the intruder states in this region. With the IS479 proposal, we put forward a study of shape coexistence in the even-mass neutron-deficient $^{198,200,202}\text{Po}$ isotopes, where the intruder structures lie higher in energy, by using post-accelerated beams from REX-ISOLDE followed by "safe"-energy Coulomb excitation.

In September 2009, the Coulomb excitation of ^{200}Po has been realised. The isotope of interest was produced with the 1.4 GeV CERN-PSB proton beam ($\sim 0.9\mu\text{A}$) impinging on a UC_x target. After diffusion out of the target material, the atoms entered the hot cavity where they were resonantly ionized with a 3-step laser ionization scheme. Unwanted surface ionized isobaric ^{200}Tl contaminants from the RILIS hot cavity were also produced. The ions were then extracted, accelerated up to 60 keV and

separated according to their mass over charge ratio, before being bunched, bred and post-accelerated up to 2.85 MeV/u with REX-ISOLDE. The obtained $^{200}\text{Po}^{48+}$ beam had a purity of 98.8(9)%. The average beam intensity delivered to a 2.0 mg/cm^2 ^{104}Pd target, located at the centre of the MINIBALL detection array, was of about 10^6 pps. A preliminary analysis of the data, taken during 56 hours, was performed. The figure shows the background-subtracted and Doppler shift corrected γ spectrum measured in coincidence with charge particles detected in a double-sided Si strip detector. The known γ -lines at 666 keV and 556 keV can be seen and result from de-excitation transitions of ^{200}Po and ^{104}Pd , respectively. The analysis is in progress to deduce the transition and diagonal matrix elements from the differential Coulomb cross section.

The reduced transition matrix elements, combined with the spectroscopy of ^{198}Po and ^{202}Po using the same technique, will be compared to beyond mean field calculations and will serve as important bench marks to test the model and interactions used.

- [1] J.L. Wood *et al.*, Phys. Rep. 215 (1992) 101.
- [2] K. Heyde *et al.*, Nucl. Phys. A 466 (1987) 189.
- [3] K. Heyde *et al.*, Phys. Rev. C 49 (1994) 559.
- [4] A.N. Andreyev *et al.*, Nature 405 (2000) 430.
- [5] J. Julin *et al.*, J. Phys. G 27 (2001) R109.
- [6] N.A. Smirnova *et al.*, Phys. Lett. B 569 (2003) 151.
- [7] A.M. Oros *et al.*, Nucl. Phys. A 645 (1999) 107.
- [8] K. Van de Vel, PhD. thesis University of Leuven, published 2003.
- [9] N. Bijmens *et al.*, Phys. Rev. Lett. 75 (1995) 4571.
- [10] T. Grahn *et al.*, Phys. Rev. Lett. 97 (2006) 062501.
- [11] T. Grahn *et al.*, Phys. Rev. C 80 (2009) 014323.

B. Bastin, N. Kesteloot, N. Bree et al.

IS486: Crystal field investigations of rare earth doped wide band gap semiconductors

Nuclear solid state physics studies of rare earth isotopes in semiconductors have a long tradition at ISOLDE, contributing significantly to an understanding of properties of and defects around rare earths in these hosts. This once started with silicon and later on semiconductors with wider band gaps were used, reaching values for the band gap of about 6 eV nowadays in the case of AlN and BN. IS486 has the aim to contribute to the knowledge of the behaviour of rare earths in wide band gap semiconductors by studying the crystal field at hyperfine levels using time differential perturbed γ - γ angular correlation (TDPAC), complementing and independently confirming optical crystal field studies that are more frequently used [2].

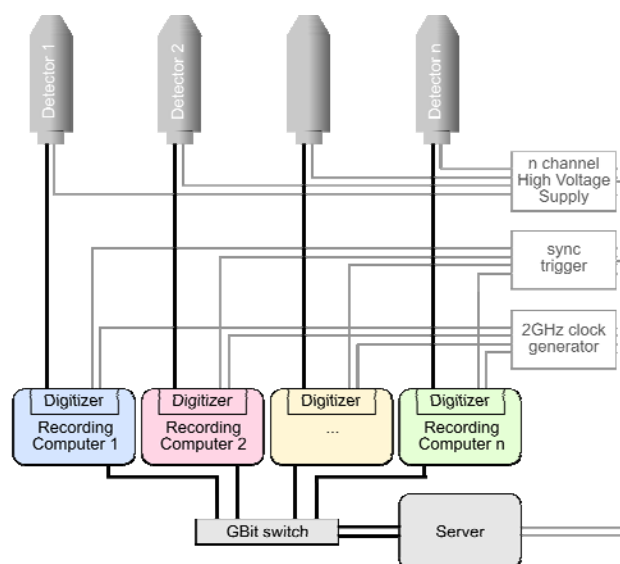

Fig. 1: Schematics of the digital PAC setup [1].

In order to tackle the challenging task of rare earth TDPAC with various rare earth isotopes, a high performance digital PAC spectrometer was developed [1]. Its basic configuration is shown in Fig. 1. The

detector (PMT + scintillate) signals are directly fed into Agilent Acqiris U1071A digitizer cards, each one hosted in a separate recording computer (quad core Xeon X5420 machine with 2.5 GHz and 4 GB RAM). These digitizers feature a maximum sampling rate of 2 billion samples per second (2 GS/s) at a resolution of max. 8 bits and a configurable input full-scale amplitude of 50 mV to 5 V. The total dead time is only 350 ns per event. A 2 GHz sine clock generator is simultaneously connected to all four digitizers to achieve reliable synchronicity and avoid jitter.

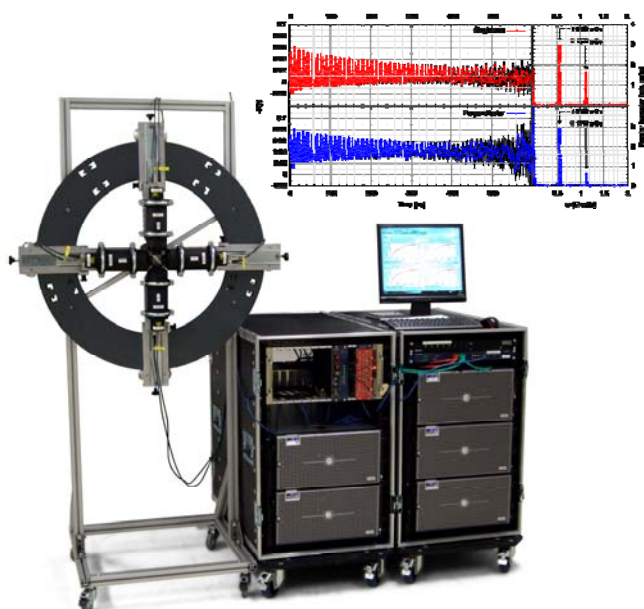

Fig. 2: Photo of the high performance digital PAC setup used for IS486 and a typical spectrum [1].

The computers are connected to a server containing a hardware RAID 5 array with eight 1 TB hard disk drives by means of a switched gigabit Ethernet network. Signal processing is completely done using software described in more detail in Ref. [2]. The setup is capable of processing more than 200.000 events/s and detector. Its main advantage is the fact that no γ -ray energy pre-selection has to be made while recording, which allows for easy off-line

PAC evaluation of nuclei with even complex decays. A picture of the real setup is shown in Fig. 2.

Besides TDPAC spectroscopy IS486 does also aim at optical spectroscopy of the radioactive rare earth element promethium, whose optical properties in semiconductors were studied for the first time ever with the help of ISOLDE [1]. Fig. 3 shows a typical high resolution Stark level spectrum of radiative intra-4f electron transitions of Pm^{3+} implanted into AlN. In this particular case the isotope ^{147}Pm was implanted. Such investigations represent important contributions to the knowledge of the Pm^{3+} 4f-electron level scheme, for which optical studies are scarce. IS486 studies the radiative intra-4f electron transitions of Pm^{3+} implanted into several popular semiconductors.

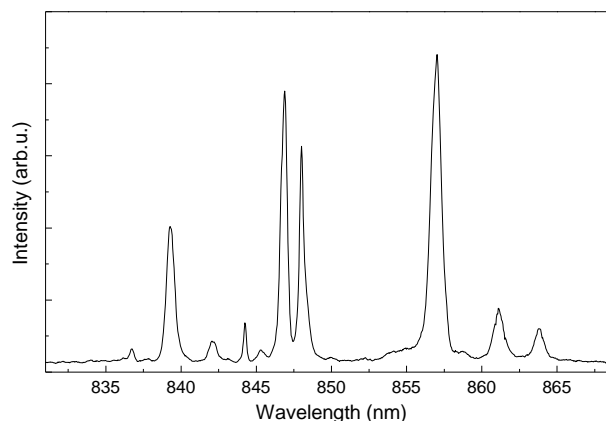

Fig. 3: Cathodoluminescence spectrum of the $^5F_1 \rightarrow ^5I_4$ intra-4f electron transition of Pm^{3+} in w-AlN, recorded at 12 K [2].

[1] M. Nagl *et al.*, submitted to Rev. Sci. Instr. (January 2010).

[2] U. Vetter *et al.*, Phys. Rev. B 74 (2006) 205201.

Ulrich Vetter

IS488: Ag(I), Pb(II) and Hg(II) binding to biomolecules studied by Perturbed Angular Correlation of γ -rays (PAC) spectroscopy: Function and toxicity of metal ions in biological systems

Our first contact with the ISOLDE was in 2006 where we carried out pilot experiments on proteins with the use of $^{199\text{m}}\text{Hg}$ ion beam. A year later we submitted our first proposal: "IS448: Pb(II) and Hg(II) binding to de novo designed proteins studied by $^{204\text{m}}\text{Pb}$ - and $^{199\text{m}}\text{Hg}$ - Perturbed Angular Correlation of γ -rays (PAC) spectroscopy: Clues to heavy metal toxicity". In that project we conducted mainly experiments on small model complexes and de novo designed proteins which were synthesized from scratch by group of Prof. Vincent Pecoraro at the University of Michigan, USA. These proteins are much simpler than the natural proteins they mimic and at the same time they are more complex than small inorganic model complexes, and their composition can be controlled. Therefore, they are excellent model systems for studying both structural and functional properties of proteins. In 2009 we submitted a new IS488 proposal which is basically a continuation of the previous one and, moreover, includes new systems, such as metallothioneins, DNA, RNA and plants.

It is well known that metal ions play significant role in most biological systems because they are involved in many essential processes in cell metabolism, such as transport, catalysis, and regulation. Roughly speaking, one third of all known proteins contain metal ions which are essential for their structure, proper function and interaction. The naturally occurring metal

ions can, however, be substituted by other, purely toxic, metal ions resulting in dysfunction of the biomolecules within leaving systems. The major aim of both projects is and was to understand the fundamental chemistry of heavy metal-biomolecule interactions and thus the mechanisms underlying heavy metal toxicity at the molecular level. In addition there may be biotechnological applications of biomolecule-metal ion complexes, for example nanowires, which are being explored in collaboration with Roland Sigel's group at the University of Zürich.

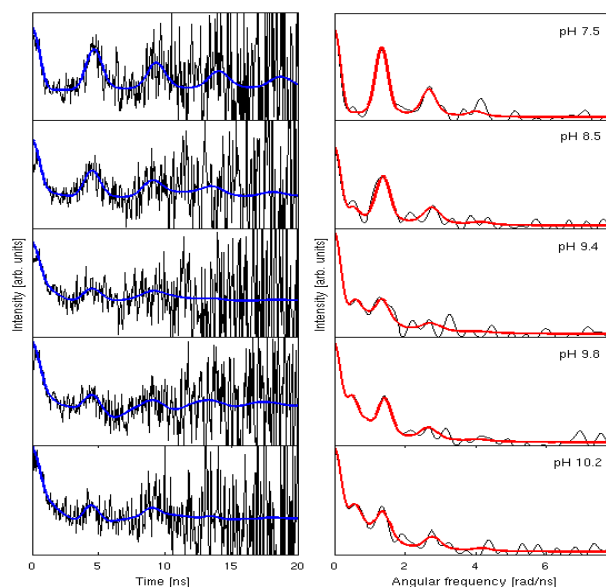

Fig. 1: $^{199\text{m}}\text{Hg}$ PAC signal from the Hg(II)-HAH1 protein complex at different pH values. A structural change at the Hg(II) binding site is observed, see the text for details.

Among the systems investigated so far (mainly in 2009) the following two examples have been selected for this newsletter:

(1) Copper transport protein in the cell (HAH1):

As can be seen on the Fig. 1 at pH 7.5 a relatively clear signal is observed. This signal agrees well with a linear coordination



geometry [HgS₂], as compared to PAC data for model systems with known structure. When pH is raised to 8.5 the major peak still occupies the same position but its amplitude drops by 1/3 of its initial value. At the same time a new peak appears at lower frequency, accounting for the loss of signal in the major peak. This lower frequency and the relatively large η indicates most likely a highly distorted four-coordination geometry, reflecting coordination of additional 2 thiolates from another HAH1 protein – a structure expected to occur during metal ion transfer between two HAH1 proteins. A further increase in pH displays the presence of two signals, however, the amplitude of the high ω_Q NQI systematically drops, whereas, the amplitude of the low ω_Q NQI systematically increases. These results are in good agreement with ¹⁹⁹Hg-NMR experiments which show the presence of only one complex at pH 7.5 and two complexes at pH 8.5. These data, which are partly repetition of experiments conducted in 2007, support the concept of a unique copper coordination environment in HAH1 that permits transfer of the metal ion from one protein to another [1].

(2) *In vivo* experiments:

^{199m}Hg-PAC experiments in 2008 and 2009 carried out on plants were, to the best of our knowledge, the very first *in vivo* experiments ever done at ISOLDE. In these experiments we let the whole barley plants soak ^{199m}Hg contaminated water and then we placed them in the PAC instrument. The recorded spectra most likely indicate Hg(II) bound in a linear [HgS₂] structure, possibly in metallothionein [2].

In order to obtain a more complete picture of the role of metal ions in biological systems, in addition to PAC spectroscopy

we and our collaborators apply other experimental techniques, such as NMR, EXAFS, UV-Vis or CD. Recently we have submitted another project at ISOLDE where we wish to try to apply a novel technique in biological systems: beta-NMR. This technique has already been successfully applied in solid state physics [3,4] and it holds great promise for successful applications in biology as well.

- [1] Wernimont *et al.*, Nat. Struc. Biol. 7 (2000) 766.
- [2] U. Heinz *et al.*, Chem. Eur. J. 15 (2009) 7350.
- [3] K.H. Chow *et al.*, 340-342 (2003) 1151.
- [4] T.A. Keeler *et al.*, Phys. Rev. B (2008) 144429.

Monika Stachura, Lars Hemmingsen

IS413&IS490: Quantum phase transitions and sub-shell closures studied with ISOLTRAP

In 2009 the Penning trap mass spectrometer ISOLTRAP [1] was used to study very neutron rich medium-mass nuclei. Among these were ⁶⁴⁻⁶⁶Mn and ⁹⁶⁻⁹⁷Kr, where only the masses of ⁶⁴⁻⁶⁵Mn were measured before. For the ionization of Mn the RILIS setup was used, which employed the new solid-state pumping lasers. The yield of Kr, on the other hand, was enhanced by the use of the new versatile arc discharge ion source, VADIS [2].

All masses except ⁹⁷Kr were determined in the ISOLTRAP precision trap using the conventional time-of-flight ion cyclotron resonance detection technique. In all cases the full measuring cycle was much lower than usual, due to the very short-half life of the investigated nuclides, making ⁶⁶Mn – with 64.4 ms half-life – the shortest lived nuclide studied at this setup. Nevertheless, even with this shortened cycle, it was still



possible to reach the relative mass precision around 10^{-7} . Kr ions – like all noble gases – easily charge-exchange with impurities in the buffer gas. In addition, the short half-life causes many beta particles which further ionise the gas. This led to contamination which was too strong for ^{97}Kr and thus its mass was exceptionally determined in the preparation trap, using the cyclotron cooling technique. The resulting ^{97}Kr mass uncertainty was 100 keV, only 5 times larger than for ^{96}Kr .

The interest in $^{64-66}\text{Mn}$, with 39-41 neutrons, is related to the question of the strength of $N=40$ shell gap, following experimental evidence suggesting that ^{68}Ni is doubly magic. Using atomic masses, the presence of a shell gap should be visible as a sudden drop in two-neutron separation energies (S_{2n}) for neighbouring isotopes. The collected data is presently being analysed [3].

Neutron-rich Kr isotopes lie directly below $Z=40$ and $N=60$ region, in which a sudden change from spherical to highly deformed shapes is present. This is an example of a quantum phase transition in nuclei, which is very well visible as an upward kink in the linear decrease of the S_{2n} within one isotopic chain. Earlier laser-spectroscopy results from COLLAPS [4] show no sudden decrease in charge radius of ^{96}Kr , which seems to contradict the recent identification of the excited state with a very low energy of 241 keV [5]. The behaviour of S_{2n} values for $^{96-97}\text{Kr}$ will help to shed light on the structure of these nuclides [6] and to define the borders of the phase transition region.

- [1] M. Mukherjee *et al.*, Eur. Phys. J. A 35 (2008) 1.
- [2] L. Penescu *et al.*, Nucl. Instr. and Meth. B 266 (2008) 4415.
- [3] S. Naimi *et al.*, to be published.
- [4] M. Keim *et al.*, Nucl. Phys. A 586 (1995) 219.

- [5] N. Marginean *et al.*, Phys. Rev. C 80 (2009) 021301(R).
- [6] S. Naimi *et al.*, submitted to Phys. Rev. Lett. (2010).

Magdalena Kowalska



How to obtain access to the ISOLDE hall

1. Register at the CERN Users office². You need to bring
 - a. [Registration form](#) **signed by your team leader or deputy**³
 - b. Proof of attachment⁴ to Institute or University **in English or French**
 - c. Passport
 - d. Copy of medical insurance (for illness, private accidents, and work accidents and disability arising from such accidents at CERN)
 - e. List of [contacts](#) in case of emergencies.
2. Get your CERN access card in [Building 55](#)

With this registration procedure you become a **CERN user**⁵.

3. Follow the CERN basic safety course (levels 1 to 3):
 - a. If you have a CERN account, you can access the Safety Awareness course on-line at the web page <http://sir.cern.ch>, from your computer, inside or outside CERN.
 - b. If you do not have a CERN account and don't foresee getting one, there are some computers available for use without the need to log in at the kiosk on the ground floor of building 55 (Your CERN badge will be needed in order to prove your identity).

² <http://cern.ch/ph-dep-UsersOffice> ([Building 61](#), open 8:30-12:30 and 14:00-16:00, closed Wednesday morning).

³ Make sure that the registration form is signed by your team leader before coming to CERN or that it can be signed by the team leader or deputy upon arrival.

⁴ Proof of attachment to Institute or University should not be signed by the person nominated as your team leader.

⁵ The first registration as USER needs to be done personally, so please note the opening hours. In case of need the extension of the registration can be delegated or performed on-line via EDH.

4. Follow the radiation protection course if you need to get a permanent personal dosimeter⁶. Please make a reservation for the course via EDH (CERN Electronic Document Handling) well in advance of your arrival at CERN⁷.
5. Obtain a radiation dosimeter at the Dosimetry service, located in [Building 55](#)⁸. Two options exist:
 - a. Temporary dosimeter. Issued only once per calendar year for a maximum of 2 months.
 - b. Permanent dosimeter. A [medical certificate](#)⁹, valid for 24 months, is required. The permanent dosimeter needs to be readout monthly¹⁰.
6. Apply for access to ISOLDE hall using EDH: <https://edh.cern.ch/Document/ACRO>. This can be done by any member of your collaboration (typically the contact person) having an EDH account¹¹.

Find more details at the [information about registration for Users](#) page.

New users are also requested to visit the ISOLDE secretariat while at CERN.

Opening hours:

Mon., Tues., Thurs., Fri. 08:30-12:30

Mon. & Thurs. 13:30-15:30

Alexander Herlert

⁶ The radiation protection course is mandatory to obtain a permanent personal dosimeter.

⁷ If it is not possible to sign up for a course, a temporary dosimeter can be issued for the first registration at CERN.

⁸ <http://cern.ch/service-rp-dosimetry> (open *only in the mornings* 08:30 - 12:00).

⁹ The medical certificate must be brought in person to the Dosimetry Service (either by the user or a representative)

¹⁰ There are reader stations at the ISOLDE hall and the CERN main building. You can leave your *permanent dosimeter* at the panel outside the ISOLDE secretariat.

¹¹ Eventually you can contact the secretary or the Physics coordinator.



Contact information

ISOLDE Secretariat

Jenny Weterings
isolde.secretariat@cern.ch
+41 22 767 5828

Chair of the ISCC

Maria Jose G^a Borge
borge@iem.cfmac.csic.es
+34 91 59 01 614

Chair of the INTC

Peter Butler
peter.butler@liverpool.ac.uk
+44 151 794 3443

ISOLDE Physics Section Leader

Yorick Blumenfeld
Yorick.Blumenfeld@cern.ch
+41 22 767 5825

ISOLDE Physics Coordinator

Alexander Herlert
(until September 30, 2010)
alexander.herlert@cern.ch
+41 22 767 3809
Magdalena Kowalska
(from October 1, 2010)

ISOLDE Technical Coordinator

Richard Catherall
Richard.Catherall@cern.ch
+41 22 767 1741

HIE-ISOLDE Project Leader

Yacine Kadi
Yacine.Kadi@cern.ch
+41 22 767 9569

More contact information at
<http://isolde.web.cern.ch/ISOLDE/normal/contacts.html> and at
<http://isolde.web.cern.ch/ISOLDE/normal/telephoneweb.htm>

